

General tolerances ISO 2768-m						Index	Date	Visum	Modification	Index	Date	Visum	Modification
Basic-size	...6	> 6 ...30	> 30 ...120	>120 ...400	> 400 ...1000								
medium	±0.1	±0.2	±0.3	±0.5	±0.8								

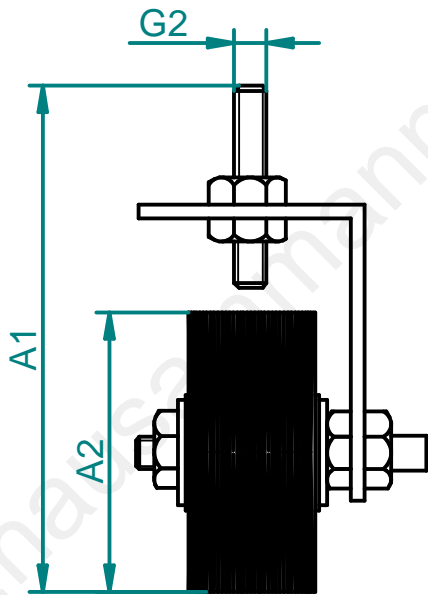

Specifications points D,K,H	
D= doc.points	
K= critical	
H= main	

Material:			
Scale			
	Date	Visum	Phone
plotted	05.08.11	E.Z	
checked			
12.662		Solid Edge	Format Index
		A4	00
Accord-draw.no.:	Origin-draw.no.:	Replacement for:	
HAUSAMMANN KOMONENTEN PRODUKTION SYSTEME			
© 2010, Für dieses Dokument behalten wir uns alle Rechte vor.		© 2 010, Nous nous reservons tous les droits sur ce document	
		© 2 010, We reserve all rights in connection with this document	